

QUATECH

DSC-100

Two Channel RS-232 Asynchronous
Communications Adapter

for PCI bus

User's Manual

QUATECH, INC.
5675 Hudson Industrial Parkway
Hudson, Ohio 44236

TEL: (330) 655-9000
FAX: (330) 655-9010
<http://www.quatech.com>

WARRANTY INFORMATION

Quatech, Inc. warrants the **DSC-100** to be free of defects for **five (5) years** from the date of purchase. Quatech, Inc. will repair or replace any board that fails to perform under normal operating conditions and in accordance with the procedures outlined in this document during the warranty period. Any damage that results from improper installation, operation, or general misuse voids all warranty rights.

Please complete the following information and retain for your records. Have this information available when requesting warranty service.

DATE OF PURCHASE:

MODEL NUMBER: DSC-100

PRODUCT DESCRIPTION: Two Channel RS-232 Asynchronous
PCI Bus Communications Adapter

SERIAL NUMBER:

© 1998 - 2006, Quatech, Inc.

NOTICE

The information contained in this document cannot be reproduced in any form without the written consent of Quatech, Inc. Likewise, any software programs that might accompany this document can be used only in accordance with any license agreement(s) between the purchaser and Quatech, Inc. Quatech Inc. reserves the right to change this documentation or the product to which it refers at any time and without notice.

The authors have taken due care in the preparation of this document and every attempt has been made to ensure its accuracy and completeness. In no event will Quatech, Inc. be liable for damages of any kind, incidental or consequential, in regard to or arising out of the performance or form of the materials presented in this document or any software programs that might accompany this document.

Quatech, Inc. encourages feedback about this document. Please send any written comments to the Technical Support department at the address listed on the cover page of this document.

DOS, Windows ME, Windows 2000, Windows 98, Windows 95, Windows NT are trademarks or registered trademarks of Microsoft Corporation. OS/2 is a registered trademark of IBM Corporation. All other trademarks or registered trademarks are property of their respective owners.

Declaration of Conformity

Manufacturer's Name: Quatech Inc.

Manufacturer's Address: 5675 Hudson Industrial Parkway
Hudson, Ohio 44236 (USA)

Application of Council Directive: 89/336/EEC

**Standards to which
Conformity is Declared:** * EN50081-1 (EN55022,
EN60555-2, EN60555-3)
* EN50082-1 (IEC 801-2,
IEC 801-3, & IEC 801-4)

Type of Equipment: Information Technology
Equipment

Equipment Class: Commercial, Residential, & Light
Industrial

Product Name: PCI Dual Serial Communications
Card

Model Number : DSC-100/IND

.....	1
1 General Information	5
1.1 Features	6
1.1.1 "IND" Option --- Surge Suppression Upgrade	6
2 Hardware Configuration	7
2.1 Factory Default Configuration	7
2.2 Enable Scratchpad Register (SPAD)	7
2.3 Force High-Speed UART Clock (X2, X4, or X8)	8
3 Hardware Installation	9
4 Address Map and Special Registers	10
4.1 Base Address and Interrupt Level (IRQ)	10
4.2 Enabling the Special Registers	11
4.3 Interrupt Status Register	11
4.4 Options Register	12
4.4.1 Enhanced Serial Adapter Identification	12
4.4.2 Clock Rate Multiplier	13
5 Windows Configuration	14
5.1 Windows Millennium	14
5.2 Windows 2000	15
5.3 Windows 98	16
5.4 Windows 1995	18
5.5 Using the "New Hardware Found" Wizard	18
5.6 Viewing Resources with Device Manager	19
5.6.1 Changing Resource Settings with Device Manager	22
6 Other Operating Systems	27
6.1 Windows NT	27
6.2 OS/2	27
6.3 DOS and other operating systems	27
6.3.1 QTPCI.EXE	28
7 External Connections	31
8 PCI Resource Map	33
9 Specifications	34
10 Troubleshooting	36

1 General Information

The Quatech, Inc. DSC-100 provides two RS-232 asynchronous serial communication interfaces for IBM-compatible personal computer systems using the PCI expansion bus. The DSC-100 uses Quatech's new Enhanced Serial Adapter design. Legacy serial port data rates are limited to a maximum of 115,200 bits per second. Quatech Enhanced Serial Adapters can achieve data rates as high as 921,600 bits per second.

As a PCI device, the DSC-100 requires no hardware configuration. The card is automatically configured by the computer's BIOS or operating system. The two serial ports share a single interrupt line and are addressed in a contiguous block of 16 bytes. A special interrupt status register is provided to help software to manage the shared interrupt.

The DSC-100's serial ports use 16550 Universal Asynchronous Receiver/Transmitters (UARTs). These UARTs contain hardware buffers (FIFOs) which reduce processing overhead and allow higher data rates to be achieved. The 16550 contains a 16-byte FIFO and can transmit and receive data at a rate of up to 921,600 bits per second. The 16550 is recommended for heavy multitasking environments and for applications involving high data rates.

The DSC-100 is supported under several popular operating systems and environments. Contact the sales department for details on current software offerings. Most device drivers are available for download from the Quatech world wide web site at <http://www.quatech.com>.

1.1 Features

The standard DSC-100 implements each of its communication channels with a 16550 UART and uses standard line driver and receiver components. For improved performance and industrial-grade reliability, Qatech offers the following board upgrades:

1.1.1 "IND" Option --- Surge Suppression Upgrade

The "IND" option provides the protection essential for reliable use in an industrial environment. Each communication line has a surge suppressor capable of sustaining up to 40A 20us peak transient surges, a clamping voltage of 30V and a peak energy dissipation of 0.1 Joules.

Part Number	IND Option
DSC-100	no
DSC-100IND	yes

Figure 1 --- DSC-100 Product Series Summary

2 Hardware Configuration

The DSC-100 is automatically configured at boot time by the computer's BIOS or operating system. There are no required switches or jumpers to set for installation.

This chapter lists a number of optional jumper settings that control various hardware features. These jumpers are grouped together at the end of the board opposite the D-9 connectors. Any changes from the factory default should be made before installing the DSC-100 in the computer.

2.1 Factory Default Configuration

Figure 2 shows the jumper configuration as shipped from the factory, with two spare jumpers applied in neutral positions. Remove one or both and apply as shown in following sections to set optional features.

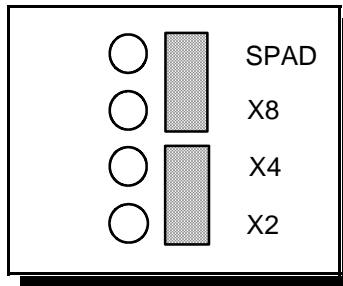

Figure 2 --- Factory default jumper configuration

2.2 Enable Scratchpad Register (SPAD)

In the default configuration, an Interrupt Status Register (see section 4.3) and an Options Register (see section 4.4) replace the scratchpad (base address + 7) of each UART. If the SPAD jumper is applied as in Figure 3, the UART scratchpad registers are enabled, and the Interrupt Status Register and the Options Register are not available.

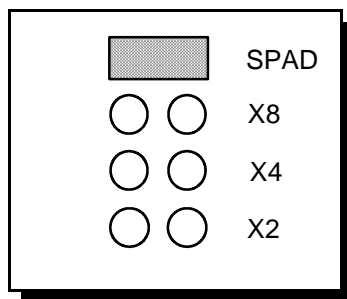

Figure 3 --- Enable scratchpad registers

2.3 Force High-Speed UART Clock (X2, X4, or X8)

These jumpers force an increase of the UART input clock frequency by a factor of two, four, or eight. This can allow legacy software to use baud rates above 115,200 bits per second. It is also useful if the serial port device driver does not directly support setting the higher baud rates through the Options Register (see section 4.4).

If one of these jumpers is applied, it overrides any value written to the Options Register to set the clock multiplier by software. The effective baud rate will be two, four, or eight times the value for which the UART itself is programmed.

The factory default is none of these jumpers applied, which allows for software control of the clock multiplier via the Options Register. The Options Register powerup default is for a standard times-1 clock of 1.8432 MHz for compatibility with standard serial ports.

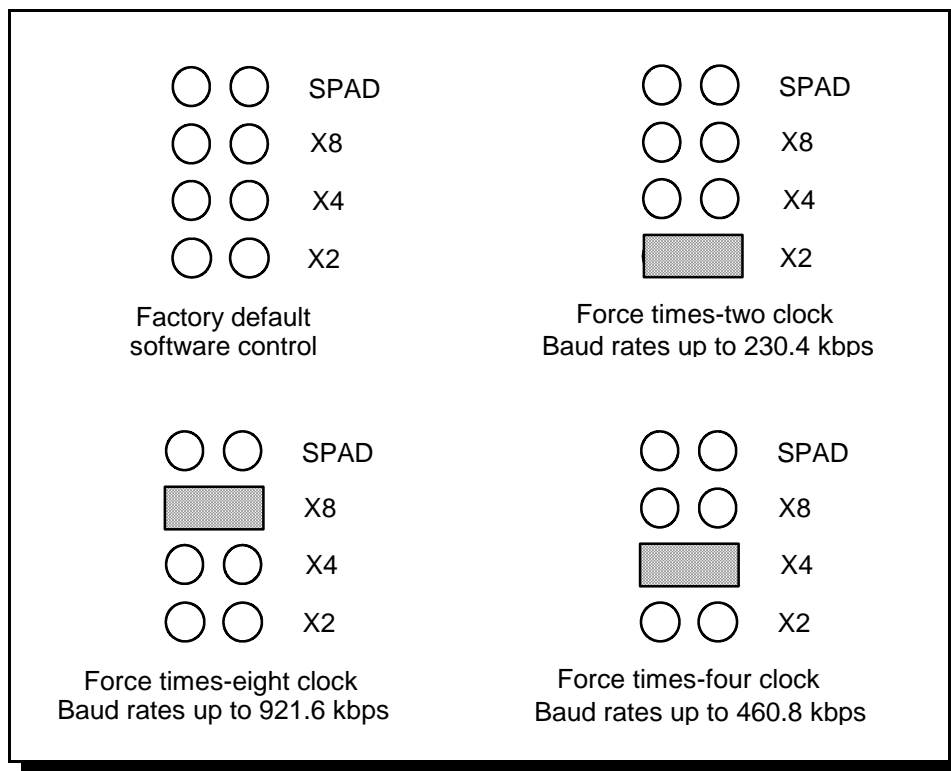

Figure 4 --- Clock multiplier jumper options

3 Hardware Installation

1. Turn off the power of the computer system in which the DSC-100 is to be installed.
2. Remove the system cover according to the instructions provided by the computer manufacturer.
3. Make any desired optional jumper setting changes.
4. Install the DSC-100 in any empty PCI expansion slot. The board should be secured by installing the Option Retaining Bracket (ORB) screw.
5. Replace the system cover according to the instructions provided by the computer manufacturer.
6. Attach and secure the cable connectors to the desired equipment.
7. Turn on the power of the computer system.

The output of the DSC-100 is a pair of 9-pin D-connectors. All modem control signals (RTS, DTR, CTS, DSR, DCD, RI) are provided to each port.

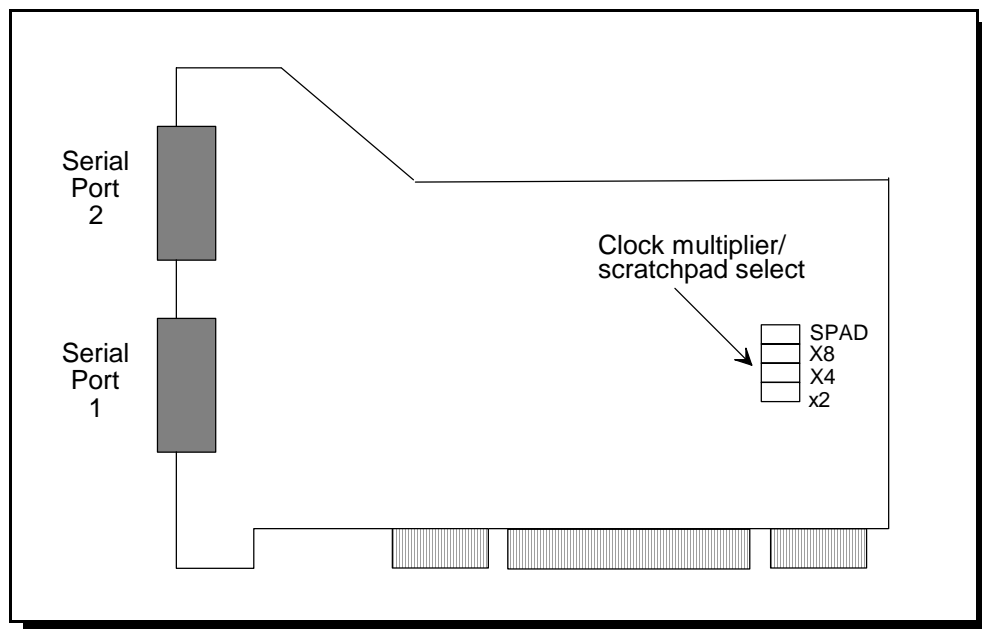

Figure 5 --- Jumper/connector locations

4 Address Map and Special Registers

This chapter explains how the two UARTs and special registers are addressed, as well as the layout of those registers. This material will be of interest to programmers writing driver software for the DSC-100.

4.1 Base Address and Interrupt Level (IRQ)

The base address and IRQ used by the DSC-100 are determined by the BIOS or operating system. Each serial port uses 8 consecutive I/O locations. The two ports reside in a single block of I/O space in eight-byte increments, along with a sixteen-byte reserved region, for a total of 32 contiguous bytes, as shown in Figure 6.

Port	I/O Address Range
Serial 1	Base Address + 0 to Base Address + 7
Serial 2	Base Address + 8 to Base Address + 15

Figure 6 --- Port Address Map

Both serial ports share the same IRQ. The DSC-100 signals a hardware interrupt when either port requires service. The interrupt signal is maintained until no port requires service. Interrupts are level-sensitive on the PCI bus.

The base address and IRQ are automatically detected by the device drivers Quatech supplies for various operating systems. For cases where no device driver is available, such as for operation under DOS, Quatech supplies the "QTPCI" DOS software utility for manually determining the resources used. See section 6.1.1 for details.

4.2 Enabling the Special Registers

The DSC-100 contains two unique registers, an Interrupt Status Register and an Options Register. These registers are enabled when the SPAD jumper is removed (factory default). They replace the UART Scratchpad Register on accesses to register address 7.

The Interrupt Status Register and Options Register are accessed through the scratchpad location of either UART. The DLAB bit of the UART (Line Control Register, bit 7) is used to select between the two registers. The most recent write of a DLAB bit in either UART selects between the two registers as shown in Figure 7.

DLAB Bit	SPAD Jumper	Register selected for address 7 accesses
0	removed	Interrupt Status Register
1	removed	Options Register
X	applied	Scratchpad Registers

Figure 7 --- DLAB bit selects between special registers

4.3 Interrupt Status Register

The read-only Interrupt Status Register can be used to quickly identify which serial ports require servicing after an interrupt. Reading the Interrupt Status Register will return the interrupt status of the entire DSC-100, as shown in Figure 8. The individual bits are cleared as the interrupting ports are serviced. The interrupt service routine should ensure that the interrupt status register reads zero before exiting.

Bit	Description
7 (MSB)	0 (not used)
6	0 (not used)
5	0 (not used)
4	0 (not used)
3	0 (not used)
2	0 (not used)
1	Port 2 --- 1 if interrupt pending
0	Port 1 --- 1 if interrupt pending

Figure 8 --- Interrupt Status Register

4.4 Options Register

The Options Register allows software to identify the DSC-100 as a Quatech Enhanced Serial Adapter. It also allows software to set the UART clock rate multiplier. Figure 9 shows the structure of the Options Register.

The powerup default of the Options Register is all bits zero.

Bit	Name	Description
7 (MSB)	ID1	ID bit 1
6	ID0	ID bit 0
5	-	(reserved, 0)
4	-	(reserved, 0)
3	-	(reserved, 0)
2	-	(reserved, 0)
1	RR1	Clock rate multiplier bit 1
0	RR0	Clock rate multiplier bit 0

Figure 9--- Options Register bit definitions

4.4.1 Enhanced Serial Adapter Identification

The ID bits are used to identify the DSC-100 is a Quatech Enhanced Serial Adapter. Logic operations are performed such that the values read back from these bits will not necessarily be the values that were written to them. Bit ID1 will return the logical-AND of the values written to ID[1:0], while bit ID0 will return their exclusive-OR.

Software can thus identify a Quatech Enhanced Serial Adapter by writing the ID bits with the patterns shown in the "write" column of Figure 10, then reading the bits and comparing the result with the patterns in the "read" column. Matching read patterns verify the presence of the Options Register.

Write		Read	
ID1	ID0	ID1	ID0
0	0	0	0
0	1	0	1
1	0	0	1
1	1	1	0

Figure 10 --- ID bit write/read table

4.4.2 Clock Rate Multiplier

A standard RS-232 serial port operates at a clock speed of 1.8432 MHz. In order to achieve higher data rates, Quatech Enhanced Serial Adapters can operate at two times, four times, or even eight times this standard clock speed. This is controlled by the clock rate multiplier bits in the Options Register.

Software can determine the UART clock frequency by reading the clock rate multiplier bits RR1 and RR0 in the Options Register as shown in Figure 11. RR1 and RR0 can be set by writing to the Options Register if the X2, X4, and X8 jumpers are all removed. If one of these jumpers is applied, the RR1 and RR0 bits are forced to the appropriate value. Reading the Options Register will always return the clock rate multiplier at which the board is operating.

RR1	RR0	Clock Rate Multiplier	UART Clock Frequency	Maximum Data Rate
0	0	X1 (default)	1.8432 MHz	115.2 kbaud
0	1	X2	3.6864 MHz	230.4 kbaud
1	0	X4	7.3728 MHz	460.8 kbaud
1	1	X8	14.7456 MHz	921.6 kbaud

Figure 11 --- Rate Register bit definition

At powerup and reset, the Options Register is initialized to 0. The DSC-100 will thus powerup in the x1 mode with software control of the clock rate multiplier enabled as long as the X2, X4, and X8 jumpers are not installed.

Software can control high baud rates through a combination of changing the clock rate multiplier and the UART baud rate divisor. For example, a baud rate of 230.4 kbps could be achieved by setting the clock rate multiplier to X2 mode (or by applying the X2 jumper) and setting a software application for 115.2 kbps.

5 Windows Configuration

5.1 Windows Millennium

1. After inserting the DSC-100 for the first time the "Add New Hardware Wizard" will begin. Select "Search for the best driver for your device.". Check the "Removable media" and "Specify location" box. Click the "Next" button.

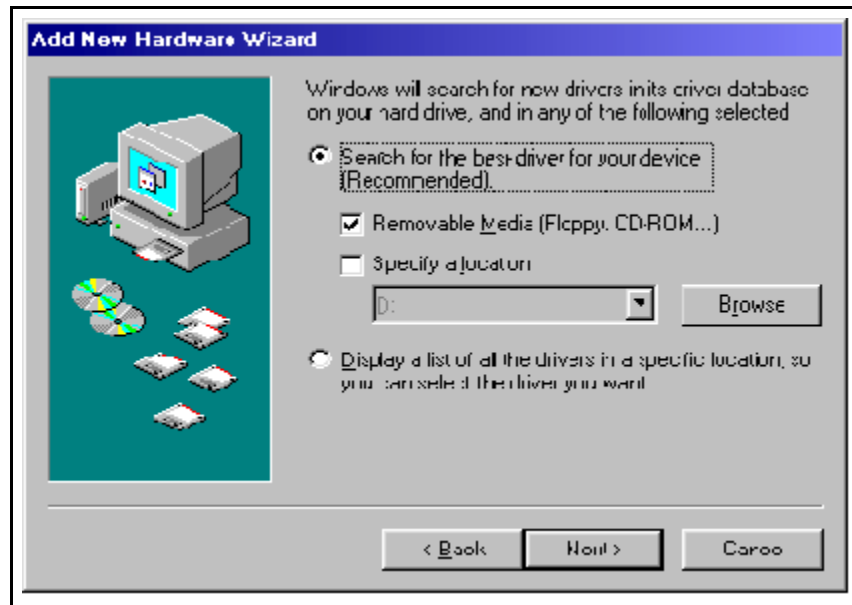

2. Window will locate the proper INF file and copy the file from the CD. Click the "Next" button.
3. The final dialog screen will verify the file copy from the CD. Click the "Finish" button.

5.2 Windows 2000

1. After inserting a DSC-100 for the first time, the "Add New Hardware Wizard will appear at start up. Click the "OK" button.

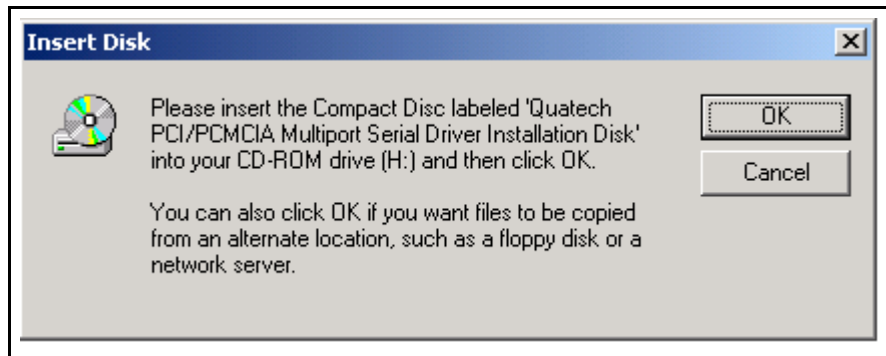

2. The following dialog box will be displayed. Insert the Communications Driver CD (shipped with the device). Click the "OK" button.

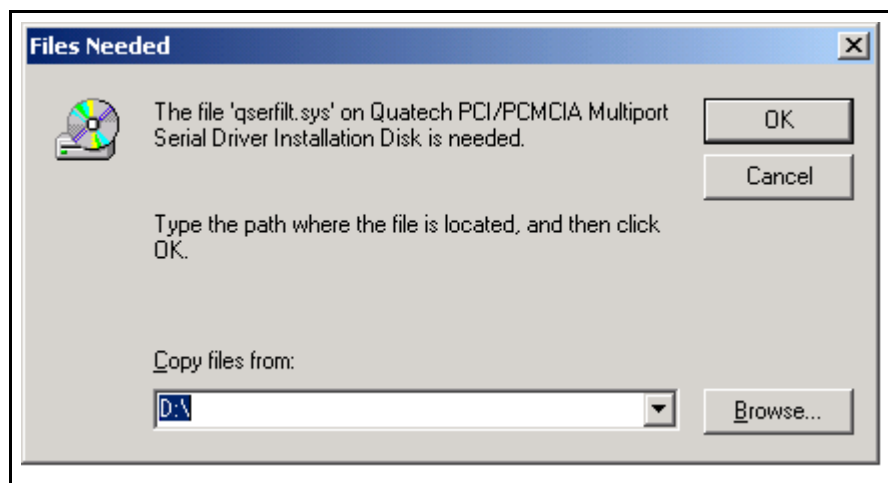

3. The following dialog box will display the appropriate INF file on the CD in drive. Click the "OK" button.
4. Window will copy the INF file from the diskette and display a final dialog indication that the process is complete. Click the "Finish" button.

5.3 Windows 98

1. After inserting a DSC-100 for the first time, the "Add New Hardware Wizard will appear at start up. Click the "Next" button.
2. Select "Search for the best driver for your device". Click the "Next" button.



3. On the next dialog, select the "CD - ROM drive" check box. Insert the Communication Drivers CD (shipped with the device) into the CD - ROM drive. Click the "Next" button.



4. The following dialog box will display the appropriate INF file on the diskette in drive. Click the "Next" button.
5. Window will copy the INF file from the diskette and display a final dialog indication that the process is complete. Click the "Finish" button.

5.4 Windows 1995

Windows 95 maintains a registry of all known hardware installed in your computer. Inside this hardware registry Windows 95 keeps track of all of your system resources, such as I/O locations, IRQ levels, and DMA channels. The "Add New Hardware Wizard" utility in Windows 95 was designed to add new hardware and update this registry.

An "INF" configuration file is included with the DSC-100 to allow easy configuration in the Windows 95 environment. Also a custom Windows 95 serial device driver is included with the DSC-100 to support the use of the 16550 UART's 16 byte FIFO. Windows 95 uses the "INF" file to determine the system resources required by the DSC-100, searches for available resources to fill the boards requirements, and then updates the hardware registry with an entry that allocates these resources.

5.5 Using the "New Hardware Found" Wizard

The following instructions provide step-by-step instructions on installing the DSC-100 in Windows 95 using the "New Hardware Found" wizard.

1. After booting the computer with a newly-installed DSC-100, the "New Hardware Found" dialog box will appear. If you have never installed a Quatech PCI communications adapter before, the dialog box may simply indicate that it has found a "PCI Card."
2. Select the radio button for "Driver from disk provided by hardware manufacturer." Click the "OK" button to continue.
3. An "Install From Disk" dialog box should pop up. Insert the disk with the Quatech INF files on it, select the correct drive letter, and click the "OK" button. Windows 95 automatically browses the root directory for an INF file that defines configurations for Multi-function Adapters. If no INF files are found, click the "Browse" button and search the Win95 sub-directory on the installation disk. You are not required to select the file name. After finding the directory containing the INF files, Windows 95 will choose the correct file.
4. The "New Hardware Found" dialog box will appear again, this time for an "Unknown Device."
5. Again select the radio button for "Driver from disk provided by hardware manufacturer." Click the "OK" button to continue.
6. Another "Install From Disk" dialog box will pop up. The path should already be pointing to the Quatech disk. Click the "OK" button to continue.
7. You should now see the "Copying Files" dialog box as Windows 95 copies the driver files from the disk.
8. The installation utility will ask for your Windows 95 installation disks. Serial communication ports require two drivers supplied by Microsoft to function:

SERIAL.VXD and SERIALUI.DLL. Insert the disk or CD and click "OK".

NOTE:

You may be able to skip this step if you are certain that your system has the latest version of these files installed. If you do not have your Windows 95 install disks immediately available, click "OK" anyway. A dialog box appears with an option to Skip the files. Click the Skip button and the files will not be installed. This is all right if the latest version of these drivers are currently in the \WINDOWS\SYSTEM directory.

9. The "New Hardware Found" dialog will repeat for each of the serial ports on the DSC-100 as each port is registered with Windows 95.
10. Installation is complete.

5.6 Viewing Resources with Device Manager

This discussion applies equally to Windows **95/98/ME** and **2000/XP**. The following instructions provide step-by-step instructions on viewing resources used by the DSC-100 in Windows using the "Device Manager" utility. Select Start|Help from within Windows for additional information on this utility.

1. Double click the "System" icon inside the Control Panel folder. This opens up the System Properties box.
2. Click the "Device Manager" tab located along the top of the System Properties box. This lists all hardware devices registered inside the Windows registry. Additional information is available on any of these devices by click on the device name and then selecting the "Properties" button.
3. Double click the device group "Multi-function Adapters". The DSC-100 model name should appear in the list of Multi-function adapters.
4. Double click the DSC-100 model name and a properties box should open for the hardware adapter.
5. Click the "Resources" tab located along the top of the properties box to view the resources Windows has allocated for the DSC-100 match the hardware configuration. **Because PCI is a true plug-and-play bus, do not attempt to modify the configuration values listed.** Click "Cancel" to exit without making changes.

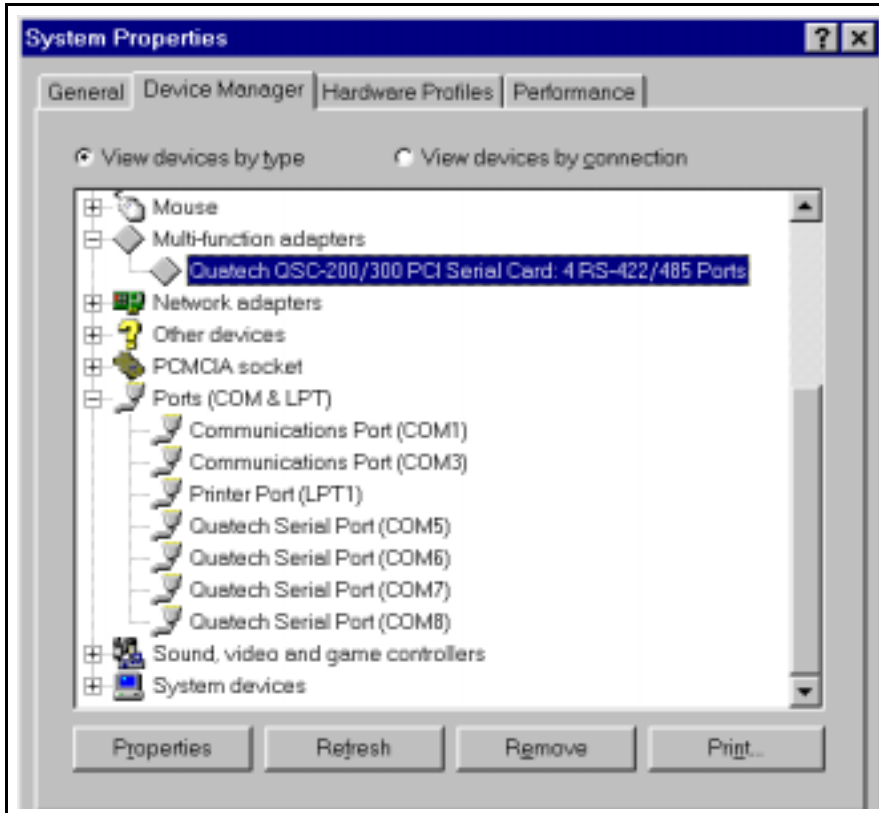

Figure 12--- Windows Device Manager

6. The DSC-100 serial ports are also listed under the group Ports (COM and LPT). Windows 95 does not assign COM1-COM4 to ports addressed at nonstandard locations. The DSC-100 ports will be enumerated starting with COM5 (or higher) even if lower logical numbers are available.
7. Select any of the Quatech Serial Ports listed under the group Port (COM and LPT) and click the "Properties" button. This action opens a properties dialog for the specific COM port on the DSC-100.
8. Click the "Port Settings" tab and then click the "Advanced" button. The DSC-100 driver will display a custom Advanced Port Settings control, which allows the ports UART compatibility mode and FIFO threshold levels to be configured. The threshold values of full-scale for the transmit buffer and 3/4-scale for the receive buffer shown below are optimal for most applications. Note that the FIFO option for each of the DSC-100's two ports is configured independently.

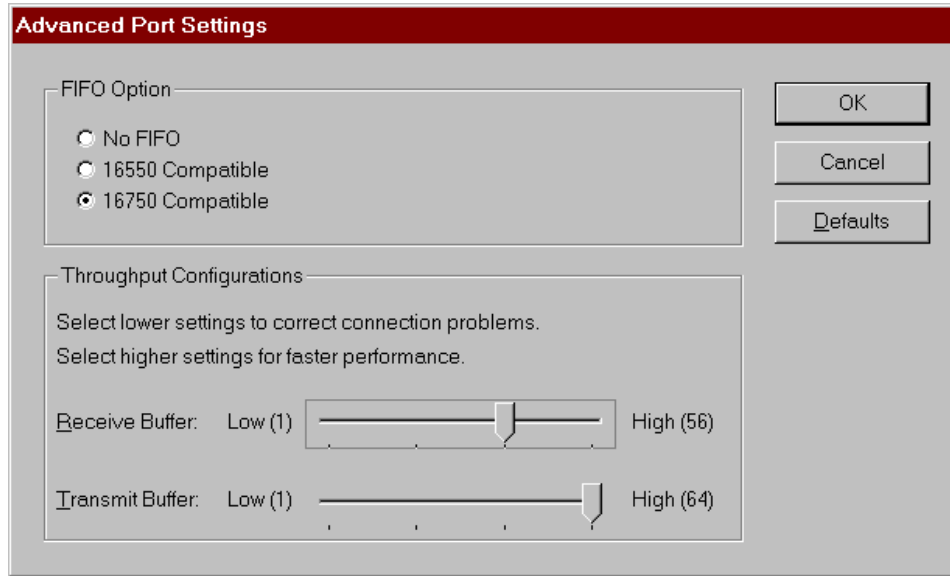
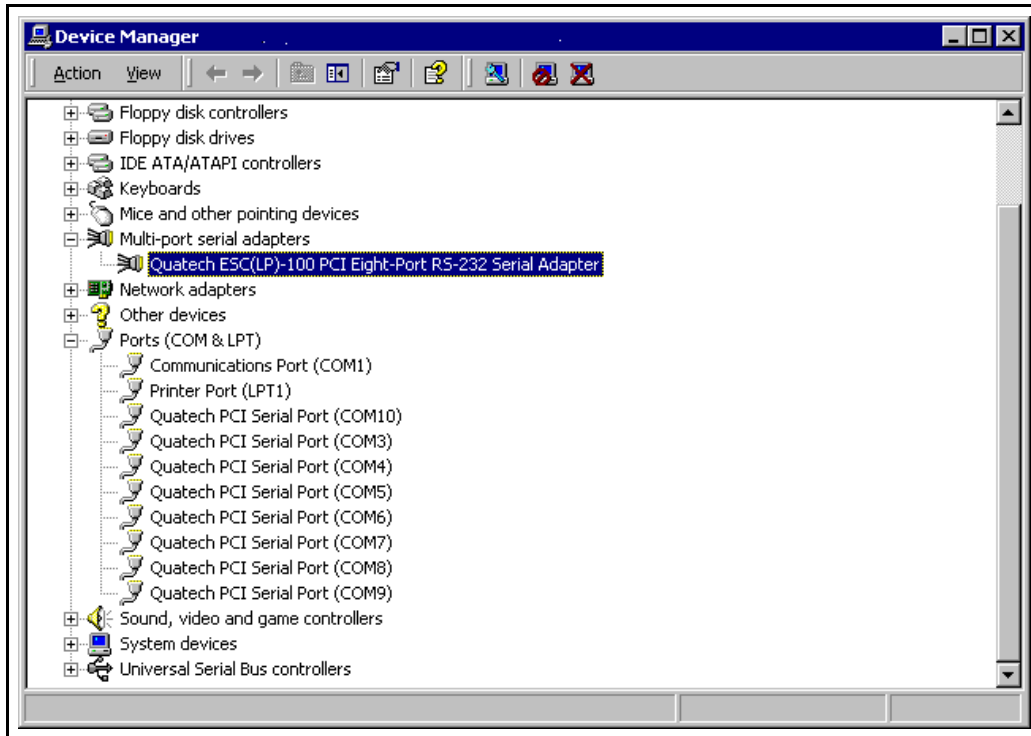

Figure 13 --- Windows Device Manager

9. Use the Logical COM Port names to access the serial ports on your DSC-100 through your software applications. Note: The Logical COM Port name is assigned to your ports by Windows. This name is required by a Windows application when accessing a particular port.

5.6.1 Changing Resource Settings with Device Manager

1. Start the Windows 95/98/ME Device Manager.



2. Double click on the hardware class **Multi-Port Serial Adapters** to list hardware devices in the class.
3. The DSC-100 “parent device” belongs to this hardware class. The full device name for the DSC-100 is **Quatech DSC-100: Dual-Port RS-232 Serial Adapter**.

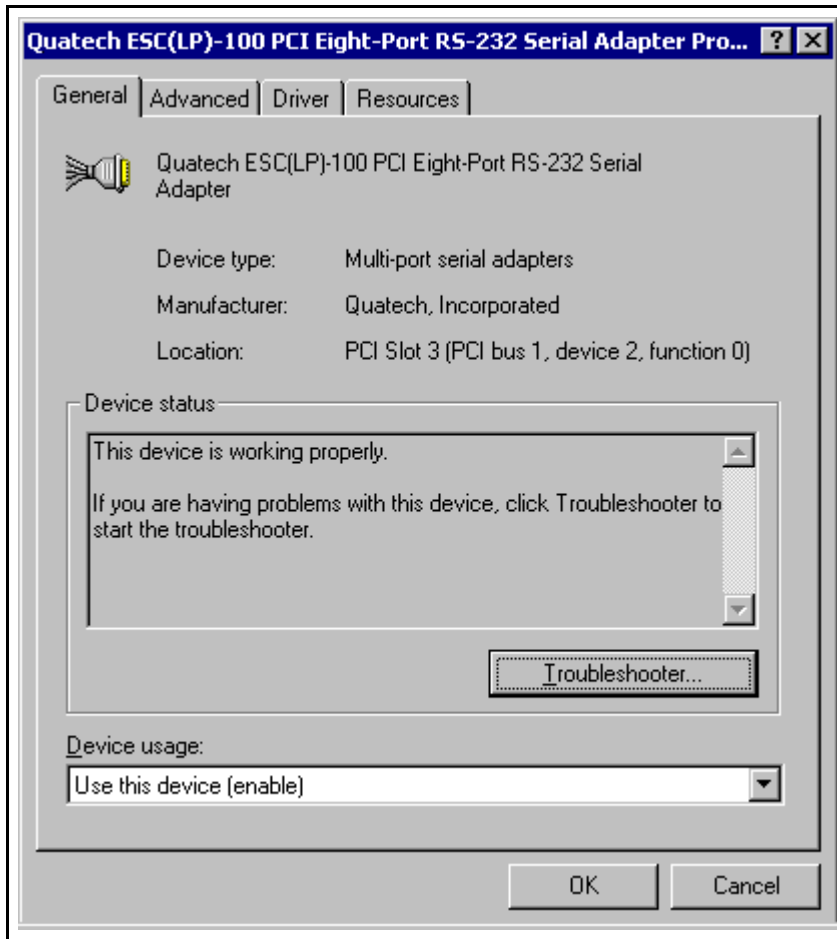

4. Open the **Properties** dialog for the DSC-100 device, then click the **Resources** tab to view the Input/Output Range and Interrupt Request resource allocations. Do not change these settings without specific instructions from a Quatech Technical Support Specialist. To exit without saving changes, click the “cancel” button.
5. Open the **Properties** dialog for the DSC-100 device, then click the **Advanced** tab to view the clock rate settings.

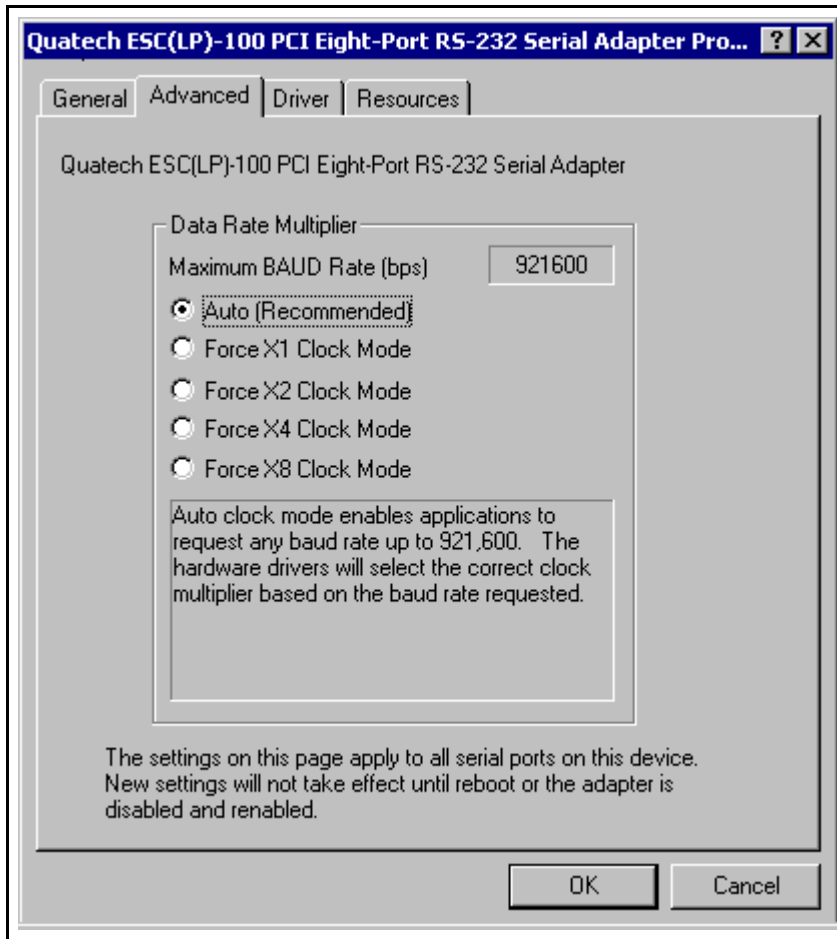

Data Rate Multiplier		
Clock Mode	Max bps	Description
Auto	921,600	Auto clock mode enables applications to request any baud rate up to 921,600. The hardware drivers will select the correct clock multiplier based on the baud rate requested
X1	115,200	The X1 clock mode mimics a standard COM port. The hardware drivers lock the clock to the standard rate. The port will run at the baud rate requested by the application.
X2	230,400	The X2 clock mode locks the ports hardware clock at double the standard rate. The baud rate the port runs at will always be double the rate requested by the applications. This mode is useful for legacy applications which cannot request baud rates over 115,200
X4	460,800	The X4 clock mode locks the ports hardware clock at

		four times the standard rate. The baud rate the port runs at will always be four times the rate requested by the application. This mode is useful for legacy applications which cannot request baud rates over 115.200.
X8	921,600	The X8 clock mode locks the ports hardware clock at eight times the standard rate. The baud rate the port runs at will always be eight times the rate requested by the application. This mode is useful for legacy applications which cannot request baud rates over 115.200.

6. Double click the hardware class **Ports (Com and LPT)**. Each **Quatech PCI Serial Port** listed in this class is a “child device” of the DSC-100 “parent device.”
7. Open the **Properties** dialog for a COM port, then click the **Port Properties** tab to view the settings for that port.

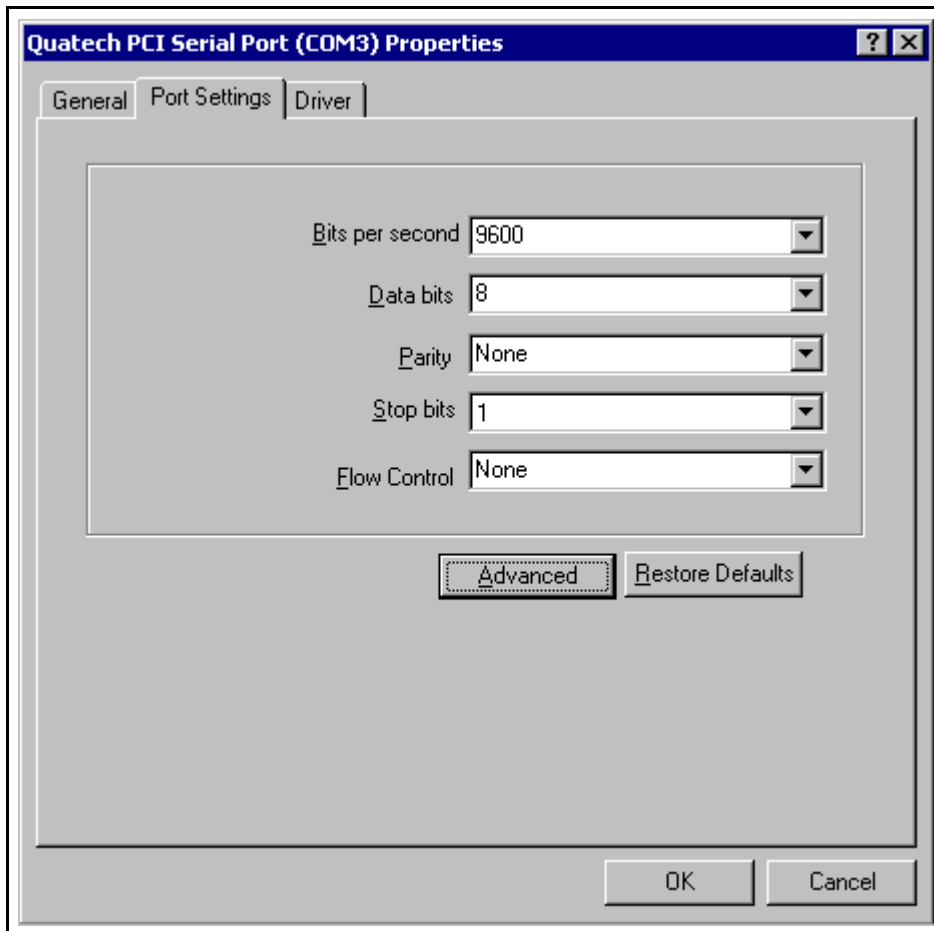

8. Click the "Port Settings" tab and then click the "Advanced" button. The DSC-100 driver will display a custom Advanced Port Settings control, which allows the ports UART compatibility mode and FIFO threshold levels to be configured. The threshold

values of full-scale for the transmit buffer and $\frac{3}{4}$ -scale for the receive buffer are optimal for most applications. Note that the FIFO option for each of the DSC-100's ports is configured independently.

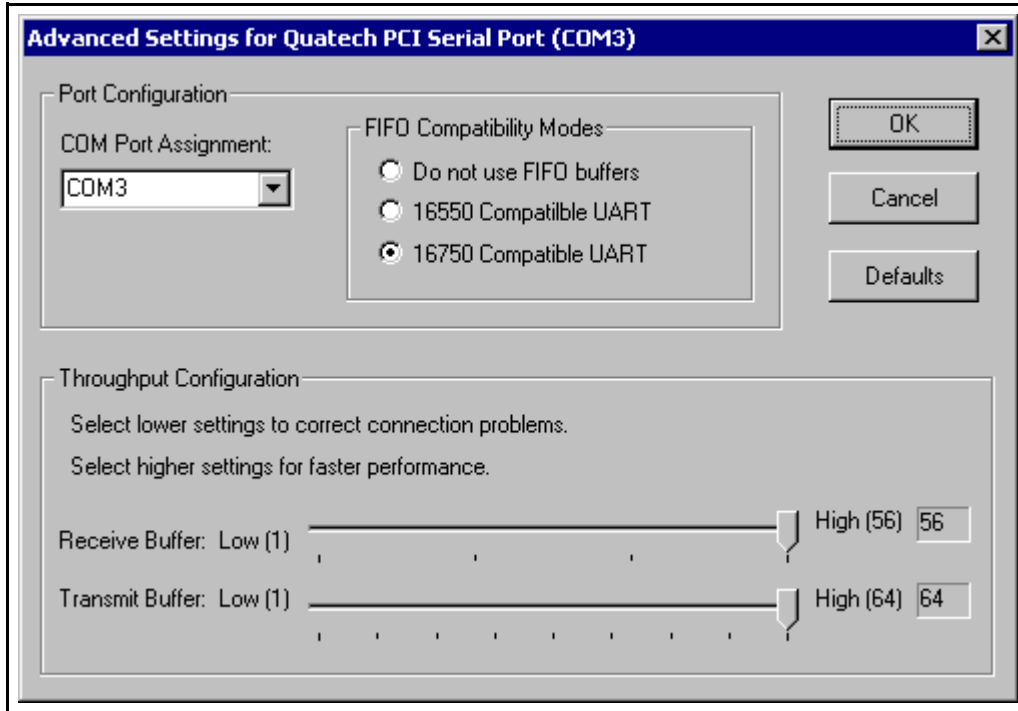

6 Other Operating Systems

Device drivers for Windows NT and OS/2 are also available for the DSC-100. The board can be used under DOS and other operating systems as well in many circumstances. The software described below can be downloaded from the Quatech web site if it did not come with the board.

6.1 Windows NT

The Windows NT device driver is installed by running the SETUP program. Up to 256 serial ports are supported. There is a command line-based configuration utility which is used for adding PCI bus and ISA bus serial ports. Please refer to the documentation included with the device driver for full installation and configuration details.

6.2 OS/2

The OS/2 device driver supports up to 32 serial ports in a system. Installation is a manual, but simple, process. Please refer to the documentation included with the device driver for full installation and configuration details.

6.3 DOS and other operating systems

The DSC-100 is not a direct drop-in replacement for a legacy serial port because its base address and IRQ cannot be fixed at values such as 3F8 hex, IRQ 4 (COM1) or 2F8 hex, IRQ 3 (COM2), etc. Rather, the system BIOS assigns the address and the IRQ in a plug-and-play fashion at boot time. Software which is to use the DSC-100 must be able to accommodate any valid assignments of these resources.

For Windows 95/98/2000/ME, Windows NT and OS/2, the Quatech device drivers determine what the resource assignments are and proceed accordingly. In other cases, however, the user must intervene. The discussion below will center on DOS, but the concepts can be applied to other operating systems as well.

Many DOS applications support user configuration of the base address and IRQ of a serial port. Such applications can generally make use of the DSC-100. Older applications, as well as some custom software, may use hard-coded standard legacy serial port addresses. These applications will require modifications if they are to use the DSC-100.

Custom applications for which the customer has source code can be modified to make just a few PCI BIOS function calls to obtain all the necessary configuration information. The PCI BIOS specification can be obtained from the PCI Special Interest Group. Contact Quatech technical support for more information.

6.3.1 QTPCI.EXE

Quatech's "QTPCI" utility supplies the information required when modifying the serial port settings of the application. This program should be run from real DOS, not in a Windows DOS box.

Figure 14 shows the Basic Mode display for the DSC-100 after the "Q" key has been pressed. In this example, the DSC-100 uses I/O base address FF80 hex and IRQ 11. The hardware revision of the DSC-100 is also displayed. Pressing the "N" key will show similar information for all non-Quatech PCI devices in the system, including those devices integrated on the motherboard.

The QTPCI program is capable only of displaying the PCI configuration. It cannot be used to make changes.

```

Quatech PCI Configuration Information Display Software
Version 1.00

INSTRUCTIONS:
-----
Press keys listed in the menu at the bottom of the screen.
This program only displays information. It cannot make changes.
Numbers preceded by "0x" are hexadecimal

    PCI BIOS detected, version 2.10

Quatech PCI adapters detected
-----
DSC-100 Two-port RS-232 adapter                (Hardware Revision A1)
Uses IRQ 11
Base addr 1 = 0xfe80    I/O
-

Q - Quatech PCI adapters                M - Change to Expert Mode
N - Other PCI devices
X - EXIT

```

Figure 14 --- QTPCLEXE Basic Mode display

Figure 15 shows the Expert Mode display for the DSC-100 after the "Q" key has been pressed. The information from the Basic Mode display is presented along with more details such as the Vendor and Device IDs, PCI Class Code, size of memory and I/O regions, etc. Pressing the "N" key will show similar information for all non-Quatech PCI devices in the system, including those devices integrated on the motherboard. In this example, the "Base addr 0" resource is reserved.

For users interested in even more details, PCI BIOS information can be displayed by pressing the "B" key. Pressing the "I" key displays the PCI interrupt routing table.

Quatech PCI Configuration Information Display Software Version 1.00	
Quatech PCI adapters detected ----- DSC-100d Two-port RS-232 adapter Vendor ID 0x135c, Device id 0x0020 found in slot 0x04 on bus 0x00 Device/function code = 0x98, Revision ID = 0x01 (Hardware revision A1) PCI Class Code = 0x070200 Communications controller, multiport serial Subsystem Vendor ID 0x135c, Subsystem Id 0x0050 INTA# mapped to IRQ 11 (route 0x62) Base addr 0 = 0xfc80 I/O 0x80 bytes allocated Base addr 1 = 0xfc20 I/O 0x20 bytes allocated —	
Q - Quatech PCI adapters N - Other PCI devices X - EXIT	M - Change to Basic Mode B - PCI BIOS details I - Interrupt routing details

Figure 15 --- QTPCI.EXE Expert Mode display

7 External Connections

RS-232-C devices are classified by their function as either Data Terminal Equipment (DTE) or Data Communication Equipment (DCE). Generally, data terminal equipment is defined as the communication source and data communication equipment is defined as the device that provides a communication channel between two DTE-type devices.

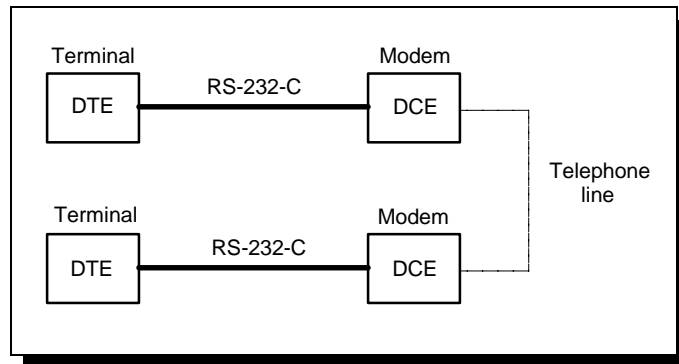

Figure 16 --- Use of DTEs and DCEs in a communications link

DTE- and DCE-type devices have complementary pinouts to allow terminals and modems to be connected directly using a one-to-one cable as shown in Figure 16. In many applications, DCEs are unnecessary, and in these cases a cable called a "null modem cable" or "modem eliminator cable" is used to directly connect two DTE-type devices. A typical null modem cable is also shown in Figure 17.

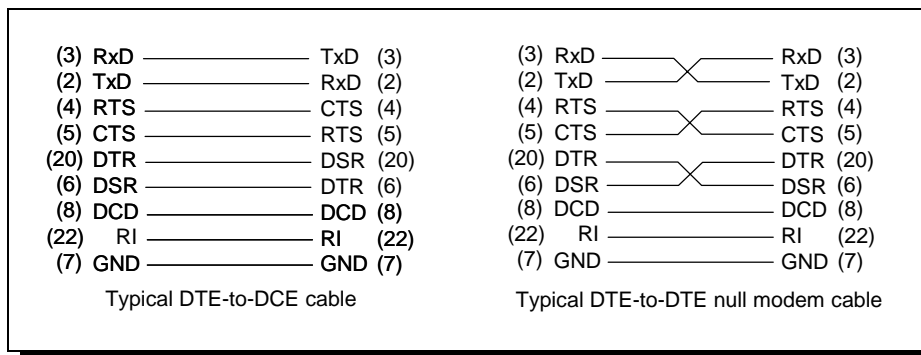

Figure 17 --- Cabling requirements for RS-232-C devices (cables using 25-pin connectors shown)

The DSC-100 is a DTE device which connects to peripheral equipment through two male D-9 connectors. An adapter cable providing two male D-25 connectors is available. The standard serial port connections are listed in Figure 18.

RS-232 Signal Description	DTE Connection		DCE Connection	
	D-9	D-25	D-9	D-25
Data Carrier Detect (DCD)	1	8	1	8
Receive Data (RxD)	2	3	3	2
Transmit Data (TxD)	3	2	2	3
Data Terminal Ready (DTR)	4	20	6	6
Signal Ground	5	7	5	7
Data Set Ready (DSR)	6	6	4	20
Request To Send (RTS)	7	4	8	5
Clear To Send (CTS)	8	5	7	4
Ring Indicator (RI)	9	22	9	22

Figure 18 --- DS-100 connector definitions for EIA/TIA-232-E

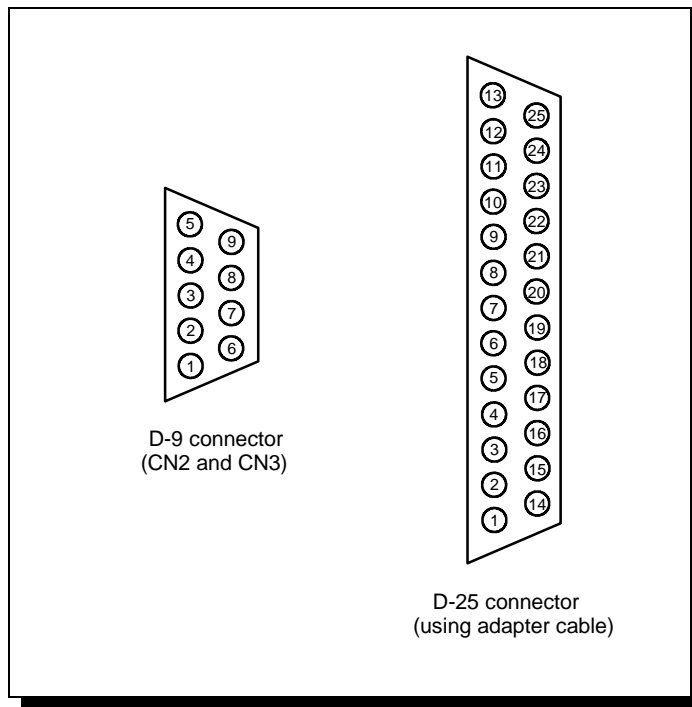

Figure 19 --- DS-100 Output connectors

8 PCI Resource Map

Listed below are the PCI resources used by the DSC-100. Such information may be of use to customers writing their own device drivers or other custom software. A detailed description of the DSC-100's UARTs is available on the Quatech web site.

(all numbers in hex)

PCI Vendor ID:	0x135C	Quatech, Inc.
PCI Device ID:	0x0181	DSC-100
PCI Class Code		
Base class:	0x07	Simple communications controller
Subclass:	0x02	Multiport serial controller
Interface:	0x00	
IRQ sourced by:	INTA#	
Base address 0:	0x80 bytes memory	Reserved region
Base address 1:	0x80 bytes I/O	
Base address 2:	0x10 bytes I/O	Serial ports
		Port 1 at offset 0
		Port 2 at offset 8

9 Specifications

Bus interface:	PCI, 32-bit bus, Universal Signalling Voltage IBM-compatible computers
Dimensions:	approx. 5.0" x 3.7"
Serial ports	
Controller:	16550 with 16-byte FIFOs
Interface:	Two male D-9 connectors, or two male D-25 connectors optional using adapter cables
Transceivers:	ICL-3245E or compatible
Driver output voltage:	low = 0.4V (max.) high= 2.7V (min.)
Receiver threshold voltage:	low = 0.6V (min.) high= 2.4V (max.)
Maximum Baud Rate:	921,600
Power requirements	
	+5 volts: approx. 250 mA
Temperature:	operating 0° to 70° storage -50° to 80°
Humidity:	10% to 90%

Data Rate (kbaud)	Maximum Load (pF)				
	4% trans time	10% trans time	15% trans time	20% trans time	25% trans time
921.6	N/A	100	300	430	470
460.8	100	430	670	900	1100
230.4	330	900	1100	1630	2000
115.2	800	1570	3300	4300	4880

Note 1: The signal transition time ratio is defined as the percentage of the unit interval or bit time (the inverse of the data rate) that is occupied by the signal transitioning from -3V to +3V. The EIA/TIA-232-E standard defines a maximum signal transition time ratio of 4%; most RS-232 receivers will recognize signal transitions with much larger ratios. With a 4% signal transition time ratio, EIA/TIA-232-E is limited to a theoretical data rate of 200 kbaud. If maximum signal transition time ratio is extended to 10%, 15%, 20%, or even 25%, the maximum data rate achievable using EIA/TIA-232-E can be increased past 200 kbaud.

Note 2: A typical value for capacitance per foot of standard cable is 50 pF/ft.

10 Troubleshooting

Listed here are some common problems and frequent causes of those problems. If the information here does not provide a solution, contact Quatech technical support.

Any unauthorized repairs or modifications will void the DSC-100's warranty.

Computer will not boot up.

1. Is the DSC-100 properly inserted? Remove the card and try again. Perhaps try a different expansion slot.
2. Ensure that an ISA-bus card is not using the same IRQ that the PCI BIOS tries to assign to the DSC-100. Most computers have BIOS setup options to reserve IRQs for either ISA or PCI use. Try reserving the IRQ for the ISA card. The BIOS will automatically choose a different IRQ for the DSC-100. An address conflict is unlikely because most PCI-based computers will assign I/O addresses in such a way that they cannot conflict with ISA-bus devices.
3. The DSC-100 may be defective. Contact technical support for instructions.

Cannot communicate with other equipment.

1. Are the cable connections correct? Are the cables securely attached?
2. Is the software configured with the correct base address and IRQ information for the DSC-100? (This is mainly a DOS issue.)
3. Is the device driver installed?
4. If you are trying to communicate with another DTE, a null-modem cable will be required.
5. If possible, use a loopback connector to test the port. This connector needs to connect the following sets of signals on a D-9 connector:

TxD and RxD (pins 3 and 2)

RTS and CTS (pins 7 and 8)

DCD, DTR, DSR, and RI (pins 1, 4, 6 and 9)

DSC-100
User's Manual
Revision 1.13
November 2006
940-0138-113